

# LEDIGAMI

Architectural Lighting Solution

## LED WALL LIGHT LITO SERIES

The LED Wall Light LITO product series is a high-performance light fixture utilising LED technology. The durable high grade material metal housing and long life LED are an ideal combination. The use of LEDs allows for the creative introduction of colour and improved energy efficiency.

A simple and robust design allows for easy luminaire installation and there is virtually no need for maintenance. It has the added advantage of being supplied factory sealed, with no requirement to open the luminaire during installation. This luminaire can operate in high humidity or wet location.

It is a powerful LED fixture with exceptional light output and is available in a wide variety of optical configurations . The luminaire has a wide variety of colour temperatures and ideally suited for the landscape application.



**4W**  
POWER

**SMD LED**  
LED TYPE

2700K  
3000K  
4000K  
6000K  
CCT

**120°**  
BEAM ANGLE

**100 - 245V**  
INPUT VOLTAGE

**IP65 IK06**  
RATING

TEMPERED GLASS / AL  
TRIM / HOUSING

**CE**  
RoHS  
COMPLIANCES

## DE-TB-FEF-AE×KCB

Light Distribution Curve [Unit: cd]

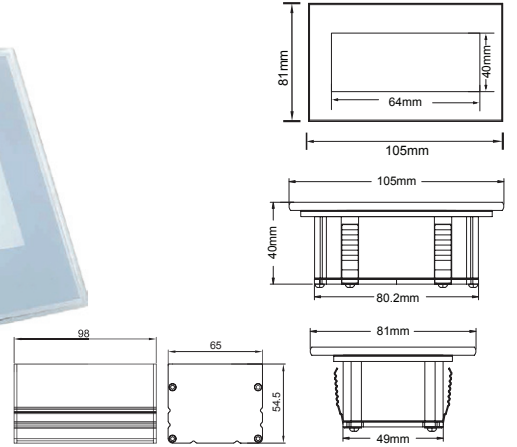
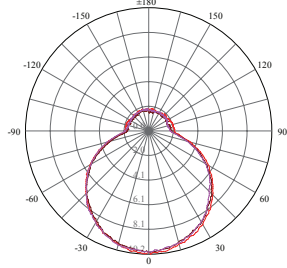

**8W**  
POWER

**SMD LED**  
LED TYPE

2700K  
3000K  
4000K  
6000K  
CCT

**120°**  
BEAM ANGLE

**100 - 245V**  
INPUT VOLTAGE

**IP65 IK06**  
RATING

TEMPERED GLASS / AL  
TRIM / HOUSING

**CE**  
RoHS  
COMPLIANCES

## DE-TB-1EE-AE×KCB

Light Distribution Curve [Unit: cd]

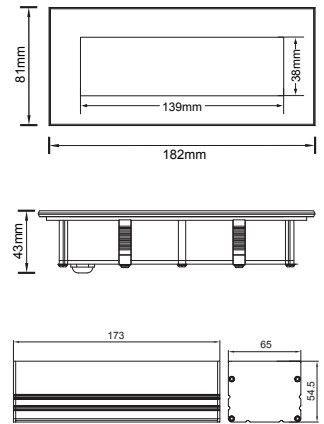
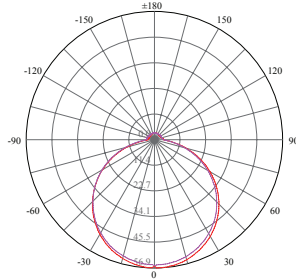

**4W**  
POWER

**SMD LED**  
LED TYPE

2700K  
3000K  
4000K  
6000K  
CCT

**120°**  
BEAM ANGLE

**100 - 245V**  
INPUT VOLTAGE

**IP65 IK06**  
RATING

TEMPERED GLASS / AL  
TRIM / HOUSING

**CE**  
RoHS  
COMPLIANCES

## DE-TB-UHF-AE×KCC

Light Distribution Curve [Unit: cd]

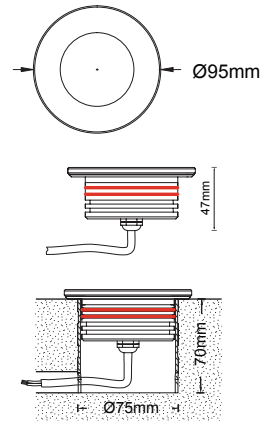
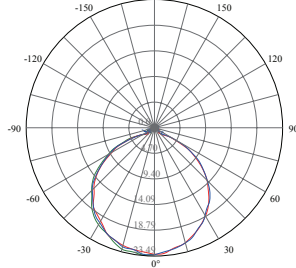

**3W**  
POWER

**SMD LED**  
LED TYPE

2700K  
3000K  
4000K  
6000K  
CCT

**45°x120°**  
BEAM ANGLE

**100 - 245V**  
INPUT VOLTAGE

**IP65 IK06**  
RATING

TEMPERED GLASS / AL  
TRIM / HOUSING

**CE**  
RoHS  
COMPLIANCES

## DE-TB-FEB-AE×A1CB

Light Distribution Curve [Unit: cd]

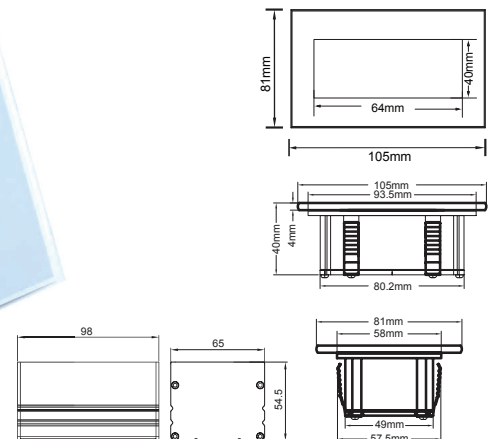
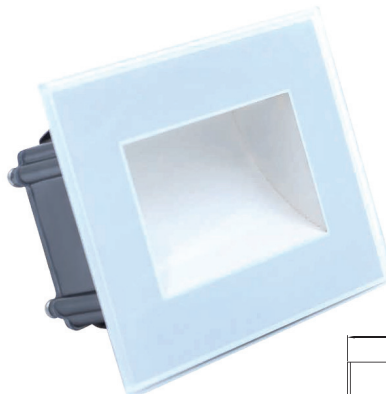
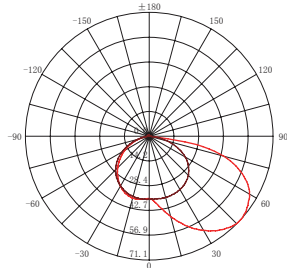

**5W**  
POWER

**SMD LED**  
LED TYPE

## DE-TB-1EL-AE×KCB

2700K  
3000K  
4000K  
6000K  
CCT

**120°**  
BEAM ANGLE

Light Distribution Curve [Unit: cd]

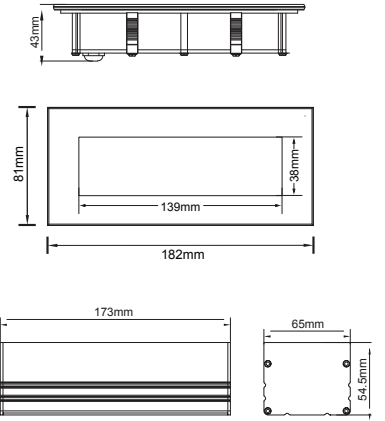
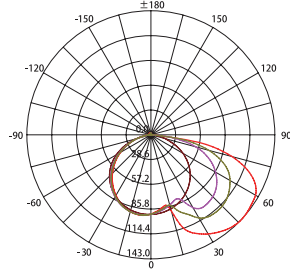

**5W**  
POWER

**SMD LED**  
LED TYPE

## DE-TB-bCL-AC×KCD

2700K (RED)  
3000K (GREEN)  
4000K (YELLOW)  
6000K (BLUE)  
CCT

**120°**  
BEAM ANGLE

Light Distribution Curve [Unit: cd]

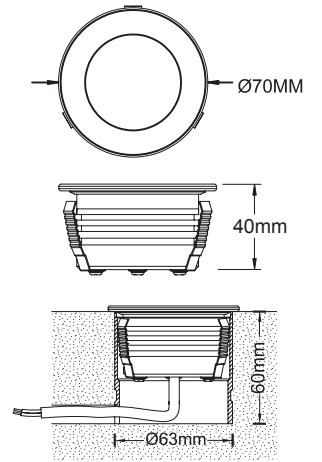
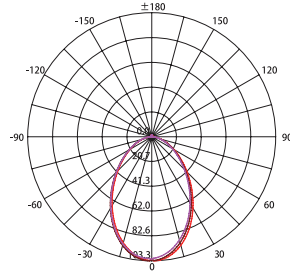

**10W**  
POWER

**SMD LED**  
LED TYPE

## DE-TB-UHP-AD×KCD

2700K (RED)  
3000K (GREEN)  
4000K (YELLOW)  
6000K (BLUE)  
CCT

**120°**  
BEAM ANGLE

Light Distribution Curve [Unit: cd]

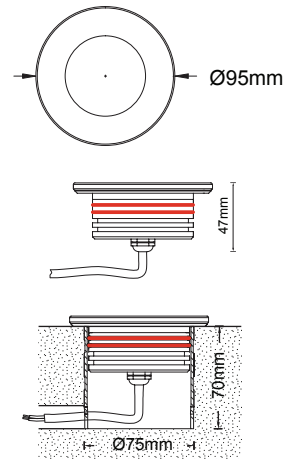
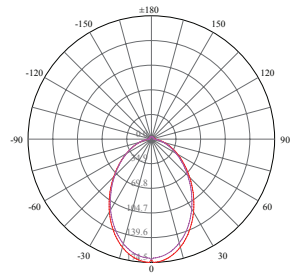

**10W**  
POWER

**SMD LED**  
LED TYPE

## DE-TB-UMP-ADNKCD

**RGB**

**120°**  
BEAM ANGLE

Light Distribution Curve [Unit: cd]

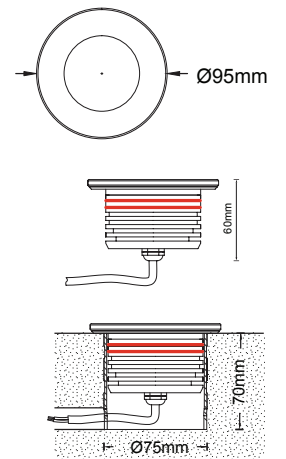
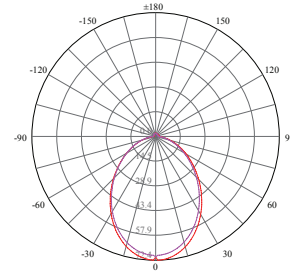

<b>10W</b> POWER	<b>SMD LED</b> LED TYPE
2700K 3000K 4000K 6000K CCT	<b>120°</b> BEAM ANGLE
<b>12 - 24V</b> INPUT VOLTAGE	<b>IP65 IK06</b> RATING
TEMPERED GLASS / AL TRIM / HOUSING	<b>CE</b> <b>RoHS</b> COMPLIANCES

## DE-TB-UUP-AF<sup>x</sup>KCD

Light Distribution Curve [Unit: cd]

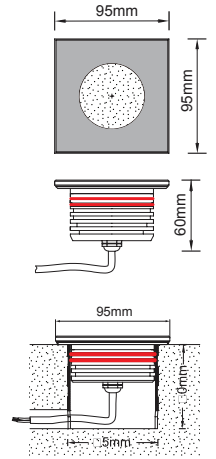
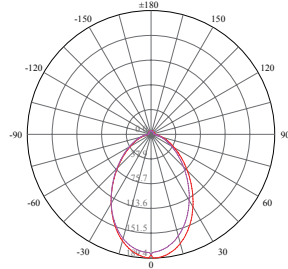

<b>5W</b> POWER	<b>SMD LED</b> LED TYPE
2700K 3000K 4000K 6000K CCT	<b>120°</b> BEAM ANGLE
<b>100 - 245V</b> INPUT VOLTAGE	<b>IP65 IK06</b> RATING
TEMPERED GLASS / AL TRIM / HOUSING	<b>CE</b> <b>RoHS</b> COMPLIANCES

## DE-TB-FEL-AE<sup>x</sup>KCE

Light Distribution Curve [Unit: cd]

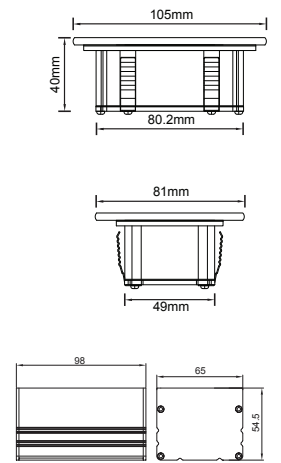
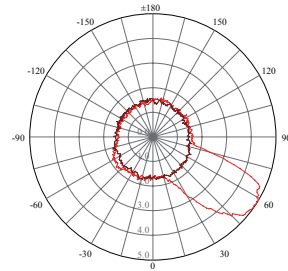

<b>3W</b> POWER	<b>SMD LED</b> LED TYPE
2700K 3000K 4000K 6000K CCT	<b>30°</b> BEAM ANGLE
<b>100 - 245V</b> INPUT VOLTAGE	<b>IP65 IK06</b> RATING
<b>AL</b> TRIM / HOUSING	<b>CE</b> <b>RoHS</b> COMPLIANCES

## DE-TB-bGB-Az<sup>x</sup>RCF

Light Distribution Curve [Unit: cd]

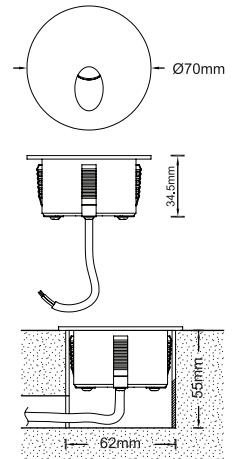
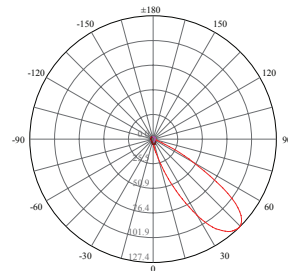

<b>3W</b> POWER	<b>SMD LED</b> LED TYPE
2700K 3000K 4000K 6000K CCT	<b>30°</b> BEAM ANGLE
<b>100 - 245V</b> INPUT VOLTAGE	<b>IP67 IK04</b> RATING
<b>AL</b> TRIM / HOUSING	<b>CE</b> <b>RoHS</b> COMPLIANCES

## DE-TB-bGB-Az<sup>x</sup>RCG

Light Distribution Curve [Unit: cd]

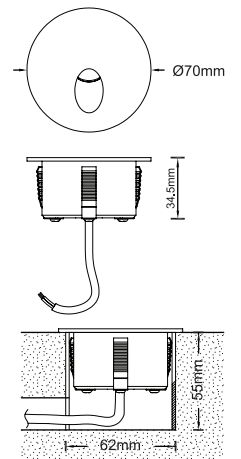
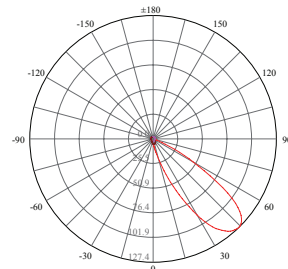

**3W**  
POWER

**SMD LED**  
LED TYPE

## DE-TB-bGB-AzRCB

Light Distribution Curve [Unit: cd]

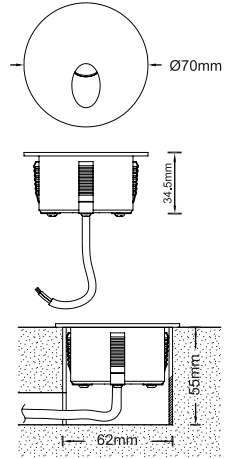
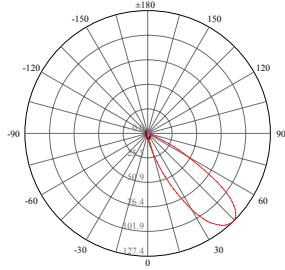

2700K  
3000K  
4000K  
6000K  
CCT

**30°**  
BEAM ANGLE

**100 - 245V**  
INPUT VOLTAGE

**IP67 IK04**  
RATING

**AL**  
TRIM / HOUSING

**CE**  
RoHS  
COMPLIANCES

**3W**  
POWER

**SMD LED**  
LED TYPE

## DE-TB-bGB-AzRCE

Light Distribution Curve [Unit: cd]

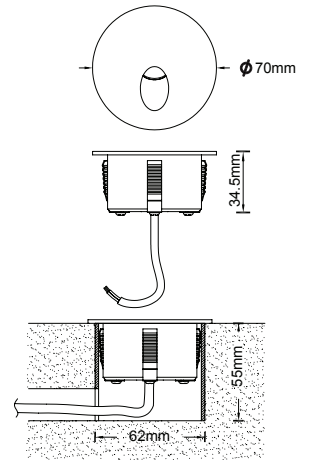
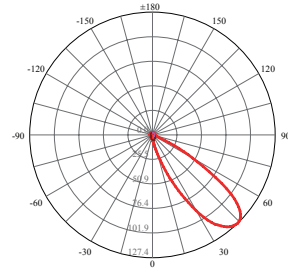

2700K  
3000K  
4000K  
6000K  
CCT

**30°**  
BEAM ANGLE

**100 - 245V**  
INPUT VOLTAGE

**IP65 IK06**  
RATING

**AL**  
TRIM / HOUSING

**CE**  
RoHS  
COMPLIANCES

**3W**  
POWER

**SMD LED**  
LED TYPE

## DE-TB-bBB-AzRCB

Light Distribution Curve [Unit: cd]

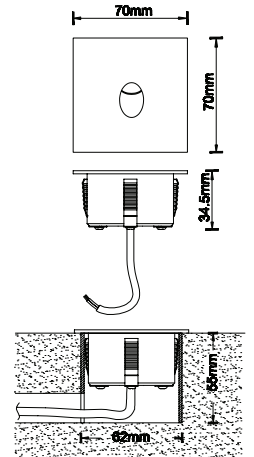
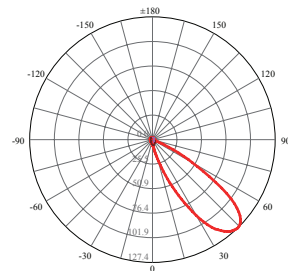

2700K  
3000K  
4000K  
6000K  
CCT

**30°**  
BEAM ANGLE

**100 - 245V**  
INPUT VOLTAGE

**IP65 IK06**  
RATING

**AL**  
TRIM / HOUSING

**CE**  
RoHS  
COMPLIANCES

**3W**  
POWER

**SMD LED**  
LED TYPE

## DE-TB-bBB-AzRCE

Light Distribution Curve [Unit: cd]

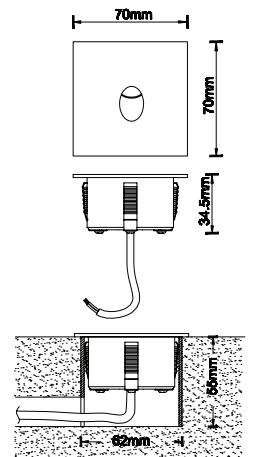
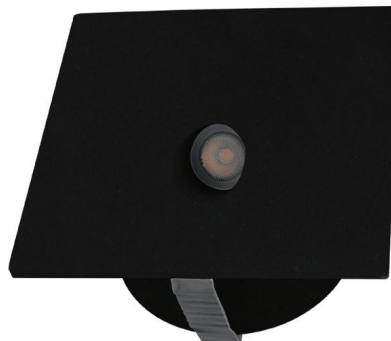
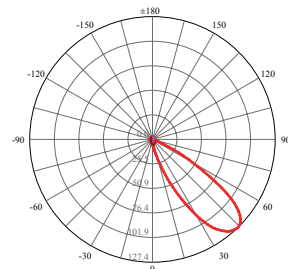

2700K  
3000K  
4000K  
6000K  
CCT

**30°**  
BEAM ANGLE

**100 - 245V**  
INPUT VOLTAGE

**IP65 IK06**  
RATING

**AL**  
TRIM / HOUSING

**CE**  
RoHS  
COMPLIANCES

<b>3W</b> POWER	<b>SMD LED</b> LED TYPE
2700K 3000K 4000K 6000K CCT	<b>30°</b> BEAM ANGLE
<b>100 - 245V</b> INPUT VOLTAGE	<b>IP65 IK06</b> RATING
<b>AL</b> TRIM / HOUSING	<b>CE</b> RoHS COMPLIANCES

## DE-TB-RJB-Az<sup>x</sup>RCF

Light Distribution Curve [Unit: cd]

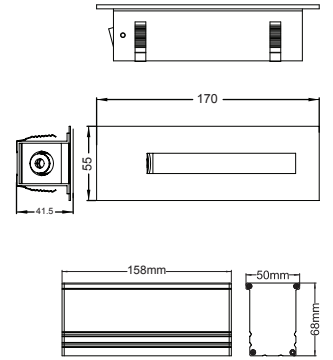
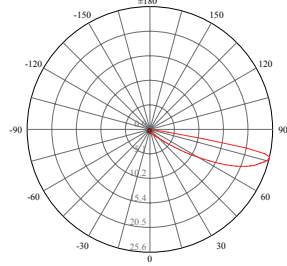

<b>3W</b> POWER	<b>SMD LED</b> LED TYPE
2700K 3000K 4000K 6000K CCT	<b>30°</b> BEAM ANGLE
<b>100 - 245V</b> INPUT VOLTAGE	<b>IP65 IK06</b> RATING
<b>AL</b> TRIM / HOUSING	<b>CE</b> RoHS COMPLIANCES

## DE-TB-RJB-Az<sup>x</sup>RCG

Light Distribution Curve [Unit: cd]

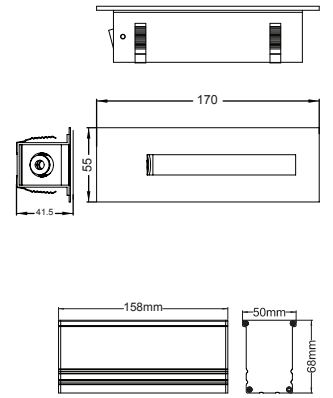
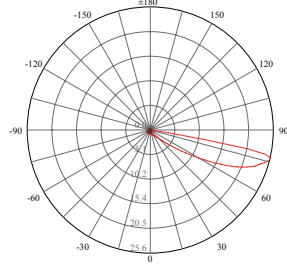

<b>3W</b> POWER	<b>SMD LED</b> LED TYPE
2700K 3000K 4000K 6000K CCT	<b>30°</b> BEAM ANGLE
<b>100 - 245V</b> INPUT VOLTAGE	<b>IP65 IK06</b> RATING
<b>AL</b> TRIM / HOUSING	<b>CE</b> RoHS COMPLIANCES

## DE-TB-RJB-Az<sup>x</sup>RCH

Light Distribution Curve [Unit: cd]

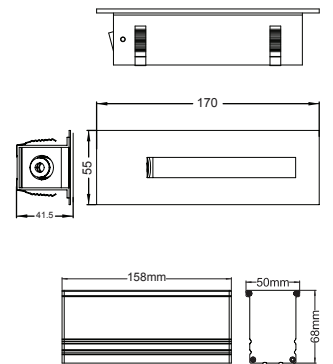
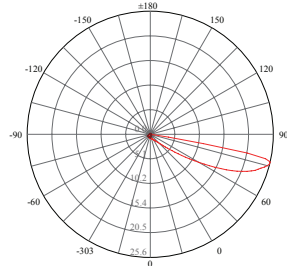

<b>6W</b> POWER	<b>COB LED</b> LED TYPE
2700K 3000K 4000K 6000K CCT	<b>24°, 36°</b> BEAM ANGLE
<b>12V</b> INPUT VOLTAGE	<b>IP67 IK08</b> RATING
<b>AL</b> TRIM / HOUSING	<b>CE</b> RoHS COMPLIANCES

## DE-KB-BEJ-Az<sup>xy</sup>AB

Light Distribution Curve [Unit: cd]

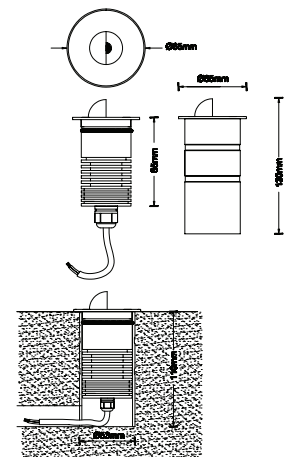
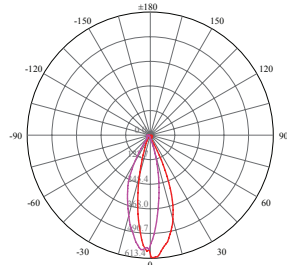

<b>8W</b> POWER	<b>SMD LED</b> LED TYPE
2700K 3000K 4000K 5000K CCT	<b>120°</b> BEAM ANGLE
<b>100 - 245V</b> INPUT VOLTAGE	<b>IP65 IK06</b> RATING
<b>AL</b> TRIM / HOUSING	<b>CE</b> COMPLIANCES

## DE-TB-dTE-AE×KCB

Light Distribution Curve [Unit: cd]

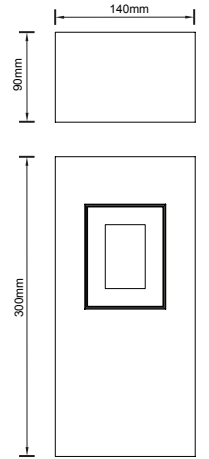
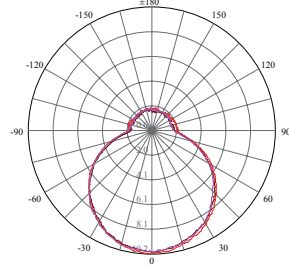

<b>5W</b> POWER	<b>SMD LED</b> LED TYPE
2700K 3000K 4000K 5000K CCT	<b>300°</b> BEAM ANGLE
<b>100 - 245V</b> INPUT VOLTAGE	<b>IP66 IK06</b> RATING
<b>AL</b> TRIM / HOUSING	<b>CE</b> COMPLIANCES

## DE-UB-3SL-AZ×A2CK

Light Distribution Curve [Unit: cd]

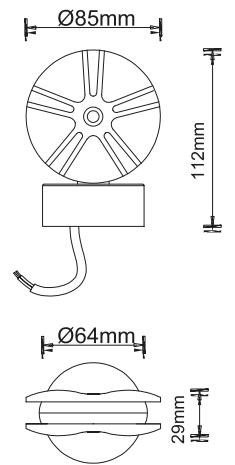
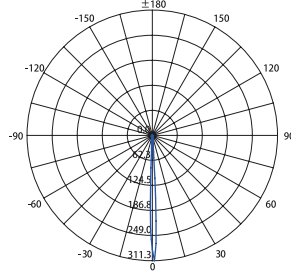

<b>5W</b> POWER	<b>SMD LED</b> LED TYPE
RGB+WW /NW/CW CCT	<b>300°</b> BEAM ANGLE
<b>24V</b> INPUT VOLTAGE	<b>IP66 IK07</b> RATING
<b>AL</b> TRIM / HOUSING	<b>CE</b> COMPLIANCES

## DE-VB-3SL-AC×A2CK

Light Distribution Curve [Unit: cd]

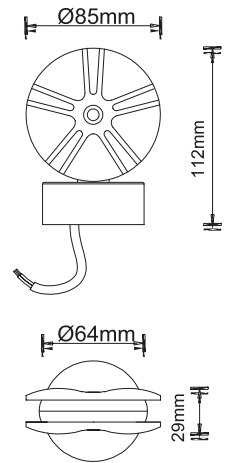
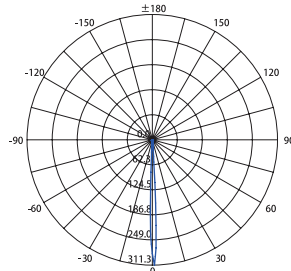

<b>5W</b> POWER	<b>SMD LED</b> LED TYPE
2700K 3000K 4000K 5000K CCT	<b>150°</b> BEAM ANGLE
<b>24V</b> INPUT VOLTAGE	<b>IP67 IK10</b> RATING
<b>AL</b> TRIM / HOUSING	<b>CE</b> COMPLIANCES

## DE-GB-VHL-AC×A3AH

Light Distribution Curve [Unit: cd]

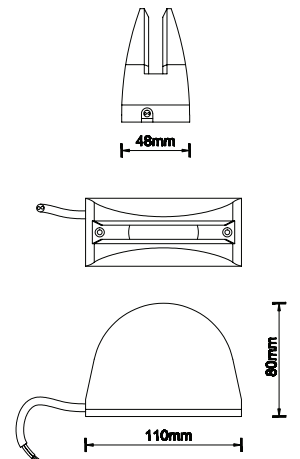
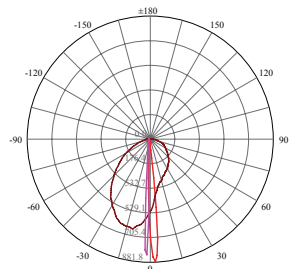

**3.5W**  
POWER

**COB LED**  
LED TYPE

## DE-WB-GHf-AE<sub>xy</sub>AG

2700K  
3000K  
4000K  
6000K  
CCT

**15°, 24°,  
36°, 60°**  
BEAM ANGLE

Light Distribution Curve [Unit: cd]

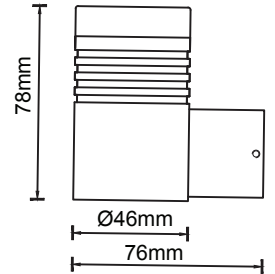
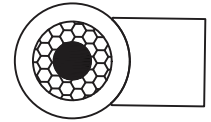
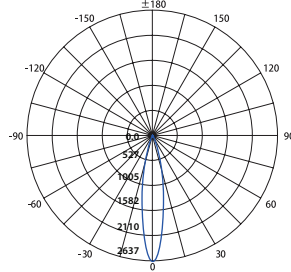

**100 -  
245V**  
INPUT VOLTAGE

**IP65  
IK04**  
RATING

**AL**  
TRIM / HOUSING

**CE**  
RoHS  
COMPLIANCES

**7W**  
POWER

**COB LED**  
LED TYPE

## DE-WB-EHe-AE<sub>xy</sub>AG

2700K  
3000K  
4000K  
6000K  
CCT

**15°, 24°,  
36°, 60°**  
BEAM ANGLE

Light Distribution Curve [Unit: cd]

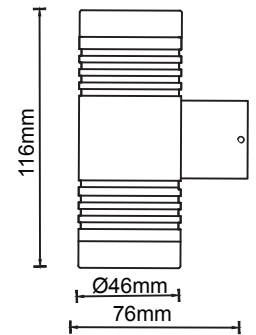
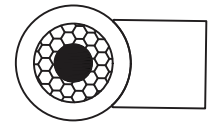
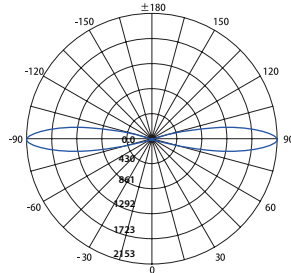

**100 -  
245V**  
INPUT VOLTAGE

**IP65  
IK04**  
RATING

**AL**  
TRIM / HOUSING

**CE**  
RoHS  
COMPLIANCES

### PRODUCT SPECIFICATION CODE

**X : CCT**

B=2700K  
C=3000K  
D=4000K  
E=6000K  
J=RED  
K=GREEN  
L=BLUE  
M=YELLOW  
T=RGB+3000K  
W=RGB+4000K  
S=RGB+6000K

**Y : BEAM ANGLE**

C=15°  
Q=24°  
U=25°  
G=36°  
P=40°  
S=60°

**Z : VOLTAGE**

C=24VDC  
D=12VDC  
E=100-245VAC

Note :

All measurement datas are subjected to 10% tolerance due to measurement equipment tolerance and accuracy  
Lumen maintenance factor : L70B50 @ normal room temperature (25 degree C)  
All product specifications are subject to change without prior notice



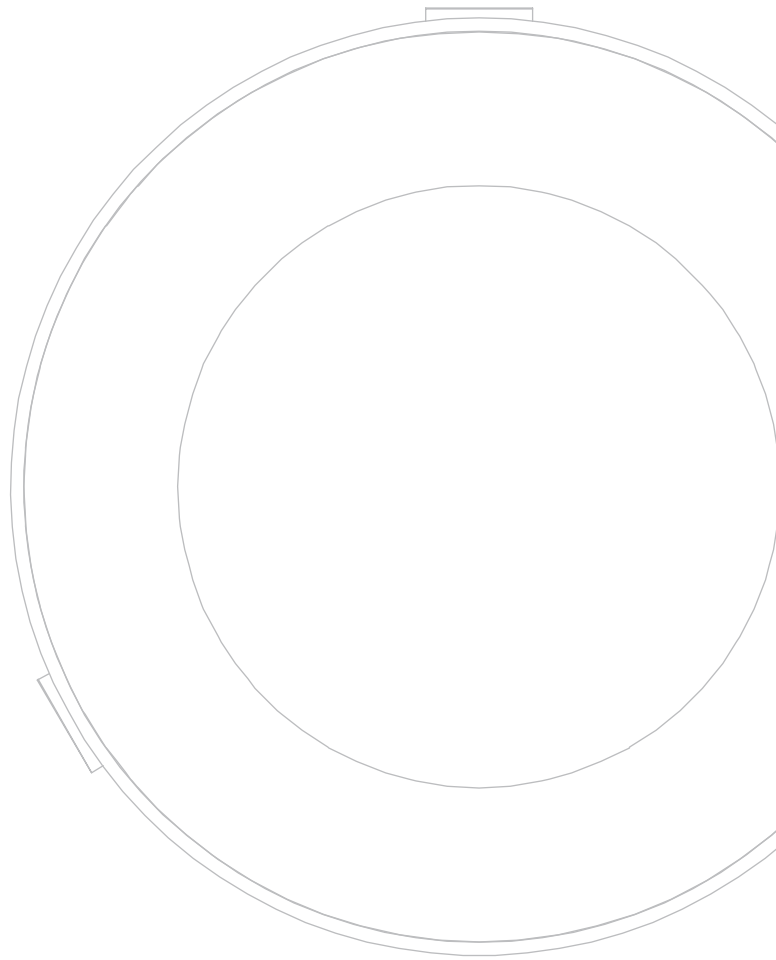

# LEDIGAMI

Architectural Lighting Solution

